

FALLOUT PROTECTION FOR...



HOMES WITH BASEMENTS

*See back cover for
your individual
Home Protection Factor*



DEPARTMENT OF DEFENSE • OFFICE OF CIVIL DEFENSE

MAY 1967 H-12 (Revised)

This booklet has been specially prepared for the householder whose basement has been analyzed for fallout protection as a result of a questionnaire filled out in the Home Fallout Protection Survey.

FALLOUT PROTECTION FOR HOMES WITH BASEMENTS

January 18, 1965



“It is already clear that without fallout shelter protection for our citizens, all defense weapons lose much of their effectiveness in saving lives. This also appears to be the least expensive way of saving millions of lives, and the one which has clear value even without other systems. We will continue our existing programs and start a program to increase the total inventory of shelters through a survey of private home and other small structures.”

A handwritten signature in black ink, which appears to be "Lyndon B. Johnson". The signature is written in a cursive style with a long horizontal line extending to the right.

President of United States

Excerpt from the President's message to the Congress

THE FALLOUT PROTECTION IN YOUR HOME



This booklet is about fallout protection. It will tell you what radioactive fallout is and how you can improve your protection against it if this country were ever attacked with nuclear weapons. But first of all, because your home has a basement, you already have some fallout protection. Let's see what that protection is:

On the back cover of this booklet a box like this appears:

BASEMENT PF (PROTECTION FACTOR)		ADDED WEIGHT
CENTER	BEST CORNER	

Entered in the space labeled Basement "PF" are two numbers which tell you the fallout protection that was calculated for the "center" of your basement and the "best corner" of your basement. Information on the box labeled "Added Weight", is on page 20 of this booklet.

The "PF" above the box stands for "Protection Factor." Before going into the details of what your "Protection Factor" numbers mean, let's talk for a moment about what fallout is.

WHAT IS RADIOACTIVE FALLOUT?

When a nuclear weapon is exploded close to the ground, dirt and other debris are drawn up into the mushroom cloud and pick up the radioactivity created by the explosion. The heaviest pieces of dirt and debris drop back to earth within a few miles of the explosion. But the lighter pieces are carried by the winds for many miles before drifting back to earth.

These radioactive particles are called "fallout." Any part of the United States might be covered with deadly or dangerous amounts of radioactive fallout, depending on which way the winds were blowing and the size and number of nuclear weapons exploded. The radioactivity could cause serious health damage or fatal injury to unprotected persons. In a nuclear attack, the

blast, heat, and fire from the explosions would be very destructive, but the destruction would be in the areas near the explosions. Radioactive fallout, though, could spread in a thin layer over millions of square miles.

Radiation would come from the fallout wherever it settled—the ground, trees and bushes, or the roof of your home. *Fallout does not behave like a gas.* In areas that would be affected by dangerous amounts of fallout, the fallout particles would look like dirt or sand and you may see them after they have settled on the ground or other places. The exact amount of radiation given off by the particles can be measured only by special instruments.

HOW CAN YOUR PROTECTION BE IMPROVED?

There are three ways of improving your protection against fallout—time, distance, and getting some heavy material between you and the fallout (called “shielding”).

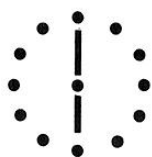

1. *Time*—Radioactivity decreases rapidly at first. After an attack, the radiation would be most intense during the first few days. Even so, radiation protection may be needed for an extended period—days or weeks.



2. *Distance*—The amount of radiation is less the further away you are from the source of radiation.

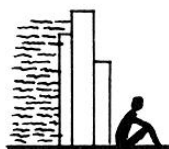

3. *Shielding*—Any material that is put between a person and the source of radiation cuts down the amount of radiation that reaches the person. The thicker and heavier the material, the better the protection.

In the event of an attack, you have little control over time and distance, but **YOU CAN DO SOMETHING TO IMPROVE YOUR PROTECTION BY MEANS OF SHIELDING.**

It is the principle of shielding that is employed in fallout shelters. Under the guidance of the Office of Civil Defense, a system of fallout shelters is being developed throughout the nation. It consists of public shelters, private shelters, industrial and home shelters.

THE FALLOUT SHELTER SYSTEM

As a result of the National Fallout Shelter Survey, in which existing large buildings were examined and evaluated for fallout protection, space for millions of people has been identified. Those community shelters having a protection factor of at least 40 and space for at least 50 people are now being marked with the familiar black and yellow shelter sign. Where necessary storage space is available, they are being stocked with food, water (if needed), sanitary and medical supplies, and radiation detection instruments. The survey is a continuing effort. Through it, a current inventory is maintained of shelters added by new construction.

The fallout protection found in homes with basements represents important additional shelter space.

Personal and other special considerations may make fallout protection at home more practical or desirable than community shelters for certain individuals or families. For example, in rural and suburban communities and even in many cities, families may live a considerable distance from the nearest community shelter. For these families, a home shelter will provide more accessible fallout protection. Fallout protection at home is usually more accessible to housewives and young children during the day and may be preferred by the whole family when at home.

HOW MUCH PROTECTION DOES YOUR BASEMENT PROVIDE AGAINST RADIOACTIVE FALLOUT?

In homes, basement areas provide the best shelter against fallout because they are mostly belowground. This gives them a natural shield. This booklet tells you the amount of protection your basement offers and what you can do to increase this protection to provide for your family's safety. Keep in mind that fallout shelter provides only limited protection against blast.

Look at the back of this booklet again. Two numbers are printed there which tell you the amount of fallout protection your basement offers. These numbers were calculated for your home by electronic computer from the information you gave in the recent Home Fallout Protection Survey questionnaire. The analytical method used is based on the best scientific information available. It was designed to give the maximum accuracy possible while requiring minimum information from you. A more complex method might produce more precise results in some cases but would sacrifice simplicity, speed and economy.

The numbers are given in terms of a "Protection Factor" or PF. This is the relation between the amount of fallout radiation

which would be received by a completely unprotected person compared to the amount which would be received by a person in a fallout shelter. For example, a person in a fallout shelter with a PF of 40 would receive about one-fortieth (or 2½ percent) of the radiation he would be exposed to if he were completely unprotected. The higher the PF for your home, the more protection your basement affords against radiation.

BASEMENT PF (PROTECTION FACTOR)		ADDED WEIGHT
CENTER	BEST CORNER	

The number in the box marked "center" (see back of your booklet) is the Basement Protection Factor (PF) calculated for the center of your basement. The other number is the PF calculated for the best corner of your basement. If your cover shows an X in place of either PF number, it means the PF is smaller than 10. Information on the box labeled "Added Weight," is on page 20 of this booklet.

WHICH IS THE BEST CORNER OF YOUR BASEMENT?

The best corner of your basement is the one which has the highest outside ground level—that is, the least amount of basement wall sticking up above-ground. In this corner make a triangle by measuring ten feet from the corner along each wall, and drawing a line between these points (see illustration).

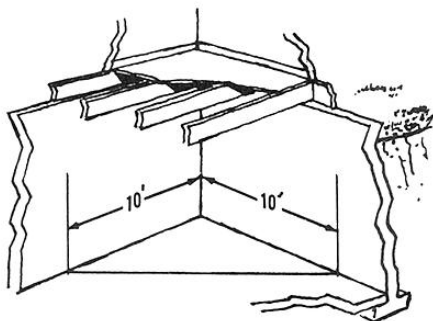

The best corner protection factor listed on the back of this booklet means the average protection factor within the triangle is above this value. This 50 sq. ft. area provides adequate fallout shelter space for 5 persons; however, if necessary, several more persons could crowd into the corner area.

A smaller area could be used if equipment such as a furnace occupies part of the corner. If additional shelter space is required or the best corner is not usable, another corner having the next highest ground level to that of the best corner could be used. If all the corners have equal outside ground levels, the most convenient corner may be used, and of course all corners may be used.

The fallout protection afforded in the corner is better closer to the wall and closer to the floor. Therefore, you should lie on the floor next to the wall or sit on the floor with your back against the wall as much as possible. You may stand to stretch, and for essential needs, you can leave the corner shelter area for a few minutes.

WHAT ABOUT THE CENTER OF THE BASEMENT?

In nearly all basements, the highest protection factor is in the corner and the lowest is in the center. This means the whole basement can be thought of as a fallout shelter with a protection factor in the center equal to the first PF number on the back of your booklet and a higher protection factor in the best corner equal to the second PF number.

STEPS YOU CAN TAKE TO INCREASE YOUR FALLOUT PROTECTION

If the protection factor in the best corner of your basement as indicated on the back cover is less than 40 and you wish to bring the PF up to the minimum recommended for public shelter, then you need additional shielding.

You can provide additional shielding for your basement by:

1. *Permanent shelters*—By making part of your basement into a shelter area or by building a permanent shelter which might also serve other purposes. Listed on the back label are the plans recommended for your home.
2. *Preplanned shelters*—By locating shielding materials so that you can complete a shelter quickly in time of crisis.
3. *Improvised shelters*—By taking last-minute improvised actions if an emergency actually occurs.

A WORD OF CAUTION TO THE HOME HANDY MAN

Fallout Shelter Plans A through F which follow are so simple that you may be tempted to construct them from the drawings in this booklet—and in many cases a thoroughly experienced “do-it-yourselfer” could do this. However, it requires very careful calculation of materials and fasteners to safely hold the heavy materials to be placed overhead; therefore, it is strongly recommended that you build from the detailed plans and lists of materials which are available by mailing the post card enclosed with this booklet.

PERMANENT SHELTER

Ceiling Modification To Basement PLAN A

NOTE: If too much of the basement wall is exposed, this plan will not provide sufficient protection and should not be used. The back cover of this booklet will indicate if this plan is recommended for YOUR home.

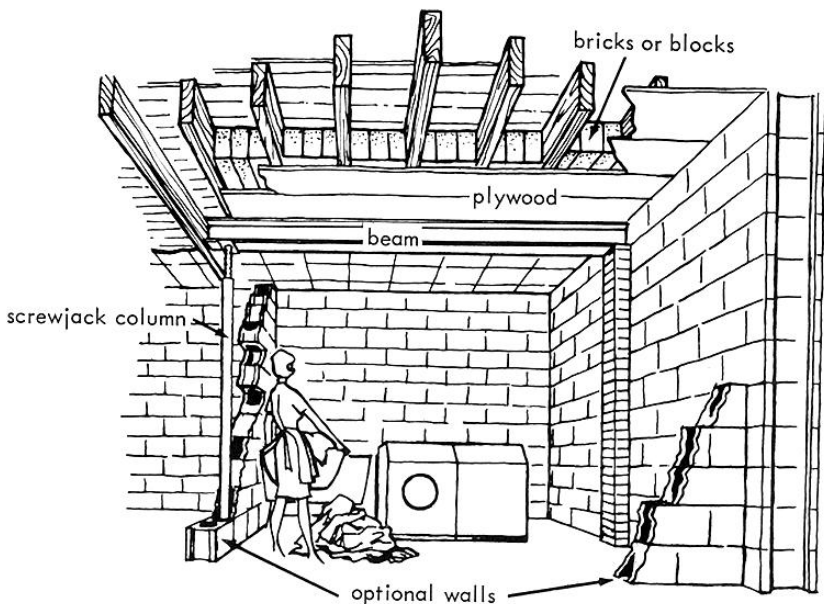

Here is a shelter which can be permanently installed in the basement of your home without affecting the use of the basement in any way.

All that is needed is a basement, some basic woodworking skills and approximately \$165 for materials. The shelter can be accomplished while the basement is being built or it can be added to an existing basement by modifying the ceiling in the corner which furnishes the best protection.

A significant amount of protection can be achieved merely by inserting heavy material in the ceiling above the best corner if this plan is recommended for your home. If this plan is not indicated on the back cover of your booklet, it can still be used by providing two additional masonry walls to enclose the corner of the basement. Fixtures and installation of ceiling tiles or walls will increase the cost a bit, but you will be able to achieve a significant amount of protection without interfering with the functions of the basement.

Because the basement area is almost all belowground level, you can increase the fallout protection by installing bricks or solid concrete blocks between the wood joists in the best corner. The filler materials are supported by sheets of plywood fastened to the floor joists. A beam and screw jack column may be needed to keep the floor joists from bending too much. A carpenter can tell you if this is needed.

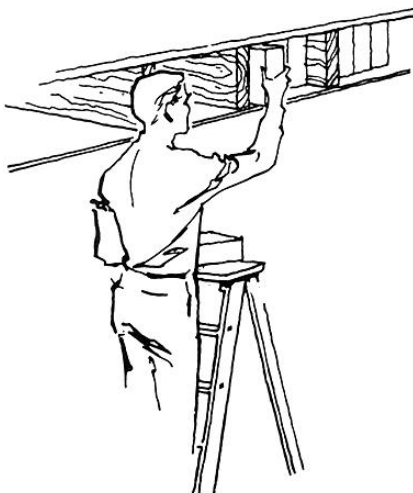
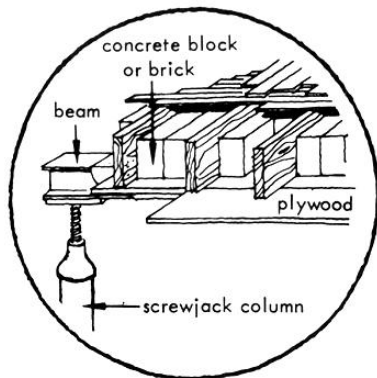

Plywood sheets (2' x 8' x 1/2" cut to fit) should be securely fastened to the joists using 2 inch, #8 screws 10 inches apart. Bricks or blocks are then packed as tightly as possible into the openings between the joists. Be sure to fill as much space as possible. To get the most protection out of this improvement, one-quarter of the basement ceiling over the best corner should be filled with bricks or solid concrete blocks.

To obtain detailed plans, see page 24.

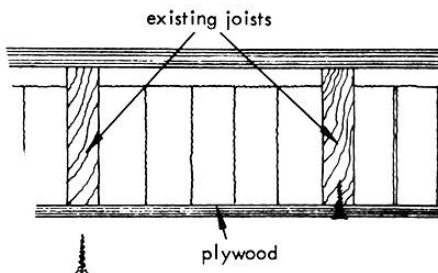

In fastening the plywood sheets to the joists, nailing is not enough. Nails will pull loose. Use two-inch screws in the manner shown here.

PERMANENT SHELTER

Alternate Ceiling Modification To Basement PLAN B

NOTE: If too much of the basement wall is exposed, this plan will not provide sufficient protection and should not be used. The back cover of this booklet will indicate if this plan is recommended for YOUR home.

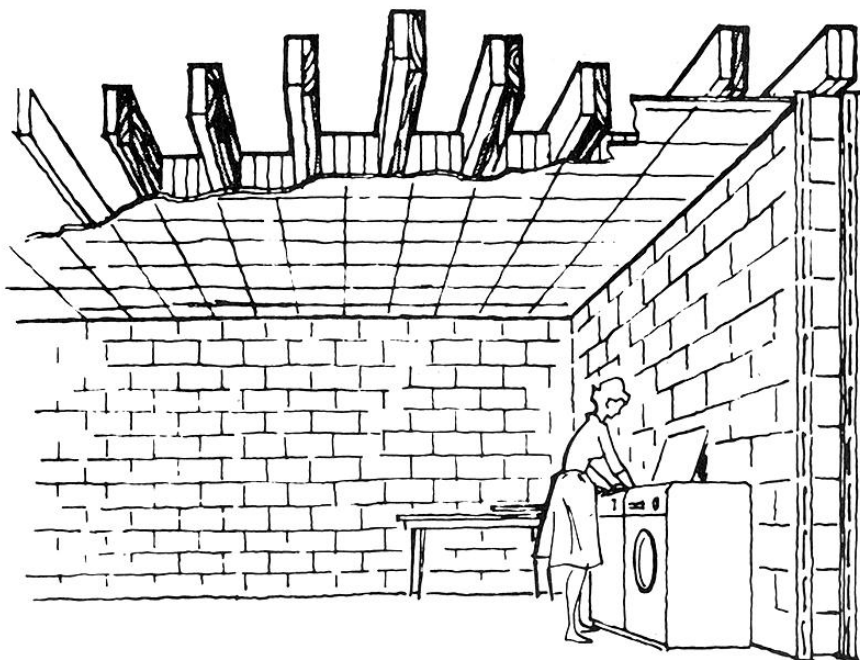

If you need a minimum shelter which will not interfere with an existing corner of your basement, try this plan. It is so arranged that the shelter area can be enlarged at either end, depending upon the size of the basement.

This type of construction does not require a beam and screw-jack column to support the joists. The protected area can be used as a workshop, recreation room, pantry area, laundry room, or part of a family room. With ceiling tile covering the plywood panels, no one would recognize the area as a fallout shelter. Since the objective is to provide as much overhead mass as possible, the heaviest weight of solid brick or block (placed on an end if possible) should be used. If this plan is not indicated on the back cover of this booklet, it can still be used by providing two additional masonry walls to enclose the corner of the basement.

Wooden joists (2" x 12"), notched at the ends for bearing, are installed between existing floor joists. Plywood panels are then fastened to the 2" x 12" joists.

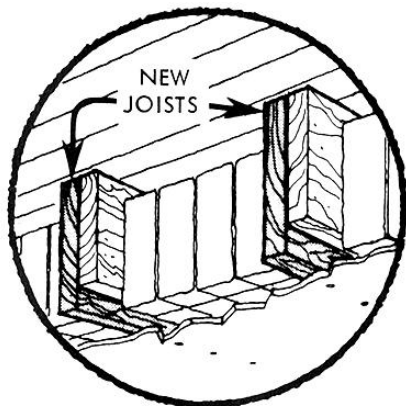
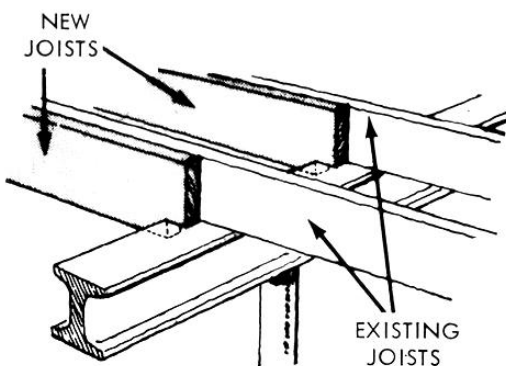

Brick or concrete blocks are packed into the spaces between the 10" and 12" joists; they are supported by the plywood panels.

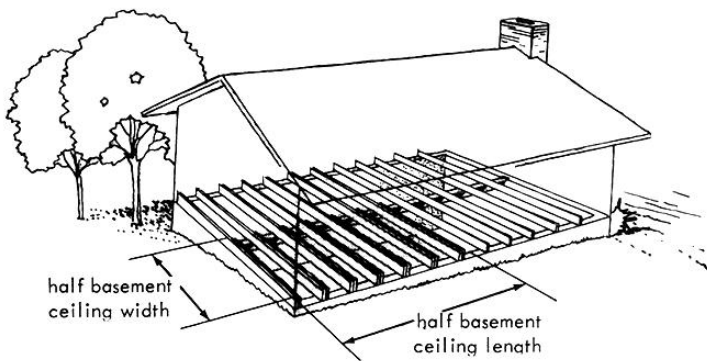

This basement floor plan shows how the additional joists and the filler material might be used in the corner of the basement which furnishes the best fallout protection. To get the most protection out of this improvement, one-quarter of the basement ceiling should be filled with bricks or solid concrete blocks.

To obtain detailed plans, See page 24.

PERMANENT SHELTER

Concrete Block Shelter PLAN C (for best corner of basement)

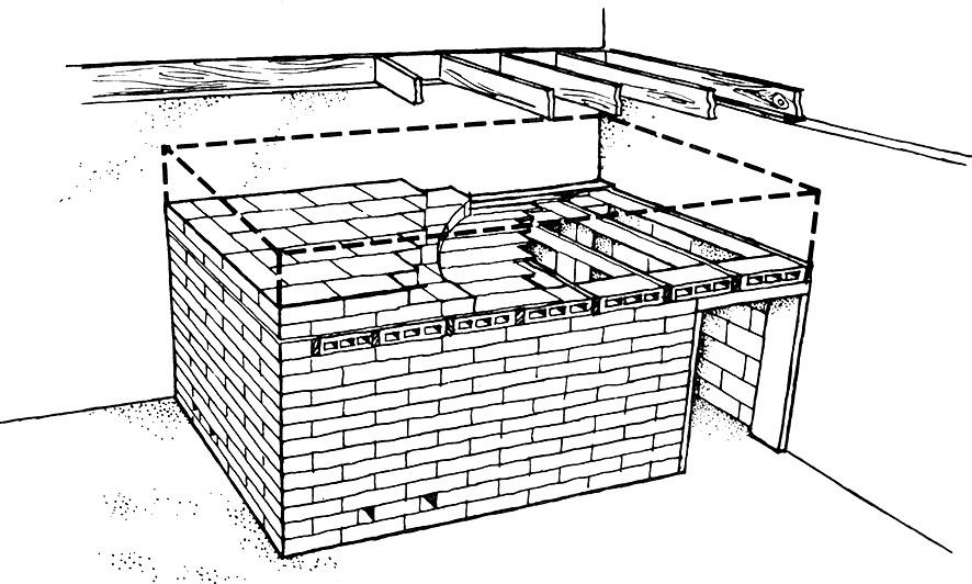

The above concrete block shelter is designed to provide a protection factor of at least 40 when placed in the basement. Its principal advantages are simple design, speed of construction and ready availability of low-cost materials. It can be designed as a sit-down shelter, or by increasing the ceiling height to 6 feet or more, it could make a more comfortable shelter and serve a dual purpose as a storage room or similar facility. The shelter ceiling, however, should not be higher than the outside ground level in the basement corner where the shelter is located. The ground level could be raised as shown on pages 18 and 19.

Natural ventilation is provided by the entrance and the air vents in the shelter wall. Materials for this type of shelter will cost an estimated \$135-\$150 depending on its height and the area of the country.

To obtain detailed plans, see page 24.

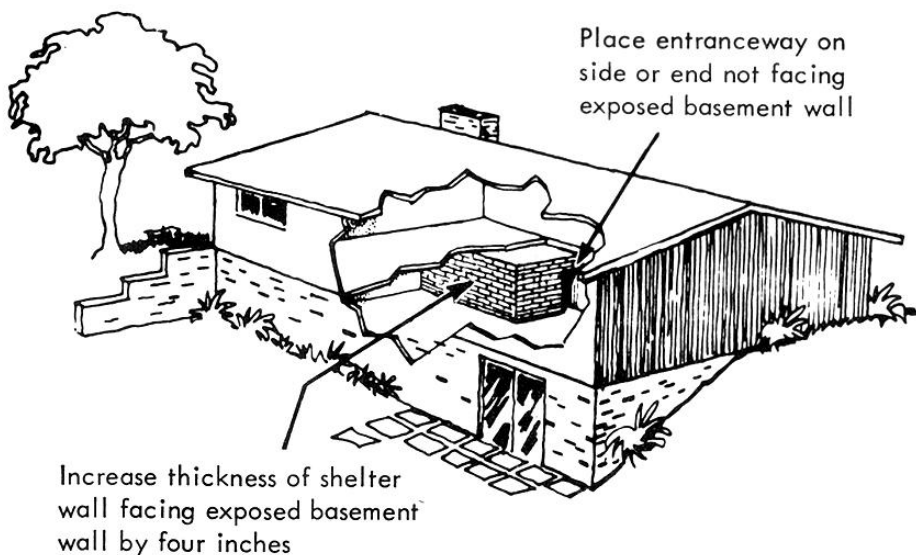

If your basement ceiling is near ground level on three sides and exposed on one side (as with "walk-in" basements), the concrete block shelter (Plan C) must be modified to achieve the desired effectiveness. The following changes should be made:

1. Increase the thickness of the shelter wall facing the basement wall which has no ground cover by four inches of brick, concrete block or similar materials.
2. Place the shelter entrance on a side or end which does *not* face the exposed basement wall.

PRE-PLANNED SHELTERS

Snack Bar PLAN D (for best corner of basement)

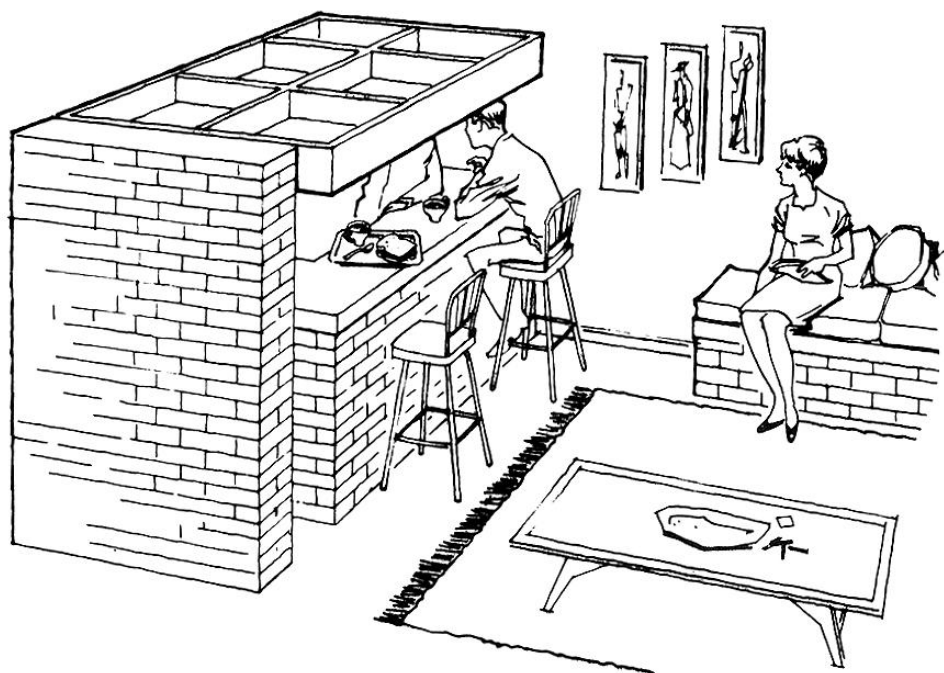

A snack bar built of brick or block can be converted into a fallout shelter in a short period of time by lowering a strong hinged false ceiling to rest on the snack bar.

The false ceiling section can then be loaded with brick or block. The bricks or blocks can be conveniently stored by incorporating them into recreation room furniture such as benches and room dividers.

An attractive bench unit for your recreation room can be made from blocks or brick. Pillows and a wood frame to enclose the bench will provide a finishing touch.

To obtain detailed plans, See page 24.

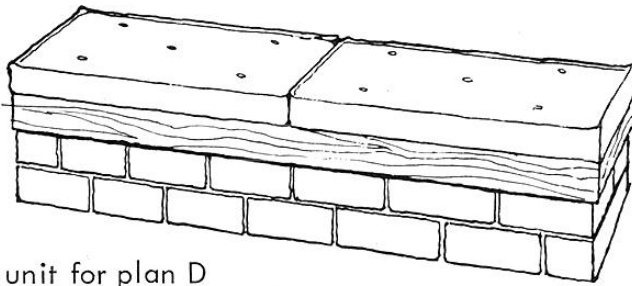

Bench unit for plan D

Tilt-Up Storage Unit PLAN E (for best corner of basement)

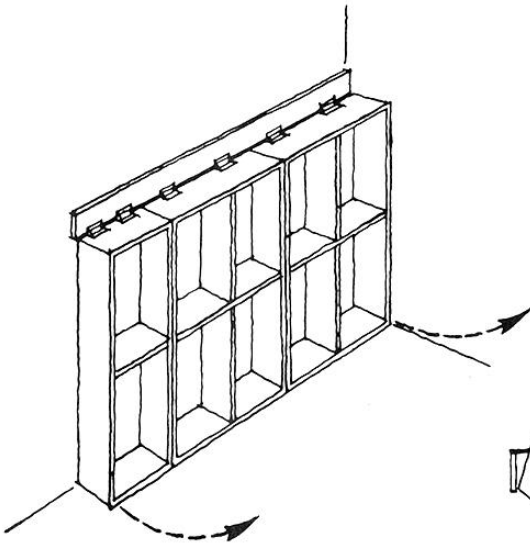

A tilt-up storage unit in a corner of your basement is another approach similar to the snack bar. The top of the storage unit can be hinged to the wall and the unit can be used as a bookcase, pantry shelves, or for miscellaneous storage.

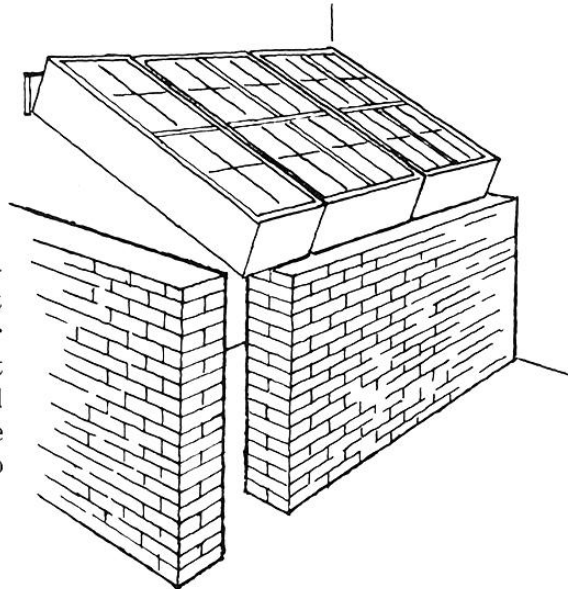

In an emergency, the storage unit can be tilted so that it rests on a wall of brick or concrete blocks stored for just such as emergency. Additional bricks or blocks can then be placed in the storage unit to provide an overhead shield.

To obtain detailed plans, see page 24.

PRE-PLANNED SHELTERS

Lean-To Shelter PLAN F (for best corner of basement)

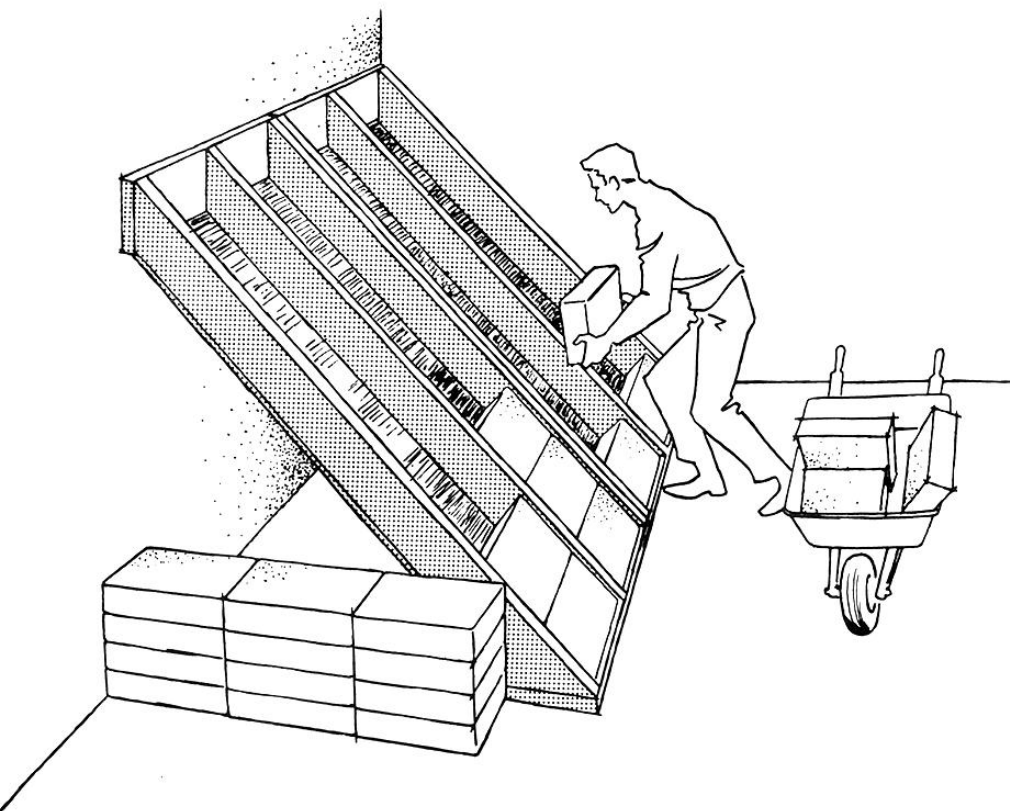

A simple and effective lean-to shelter can be built by constructing the components and storing them in your basement where they can be quickly assembled in an emergency. Components consist of a frame and filler materials, such as brick or blocks.

For detailed plans, see page 24.

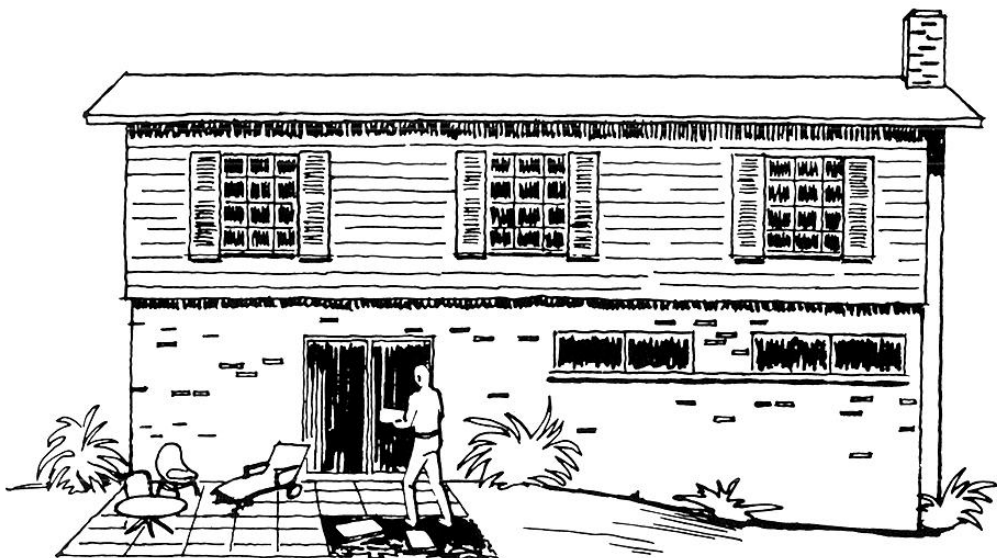

A patio of brick or concrete block supported on a bed of sand will provide a ready source of shielding material which could be quickly removed for use in an emergency. See Plans D, E and F.

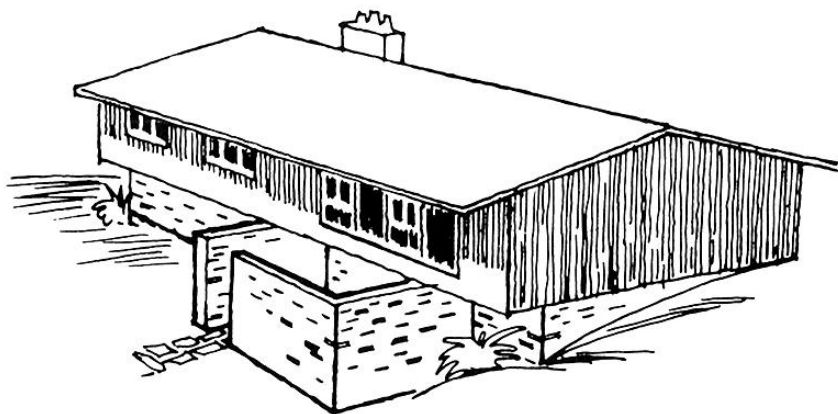

Enclosing your patio area with a solid masonry screen wall will give you privacy for lounging and cook-outs, and will provide a barrier shield to increase the PF in the basement area.

AN ELEVATED FLOWER GARDEN

BEFORE

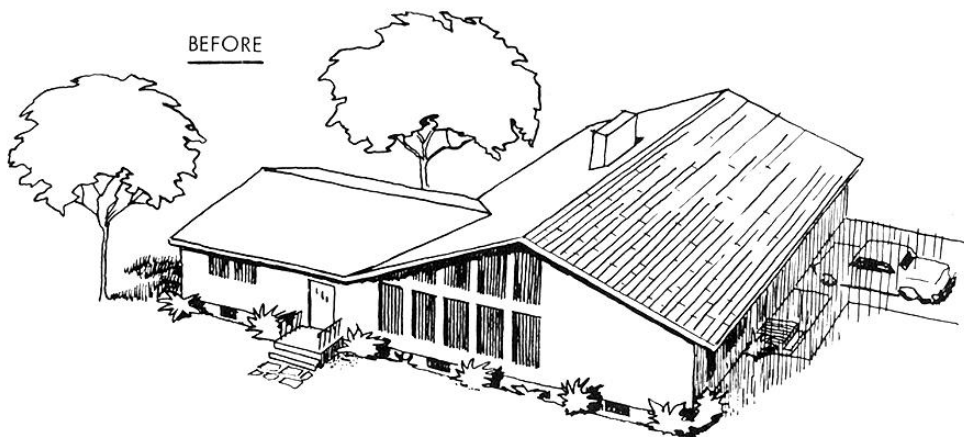

AFTER

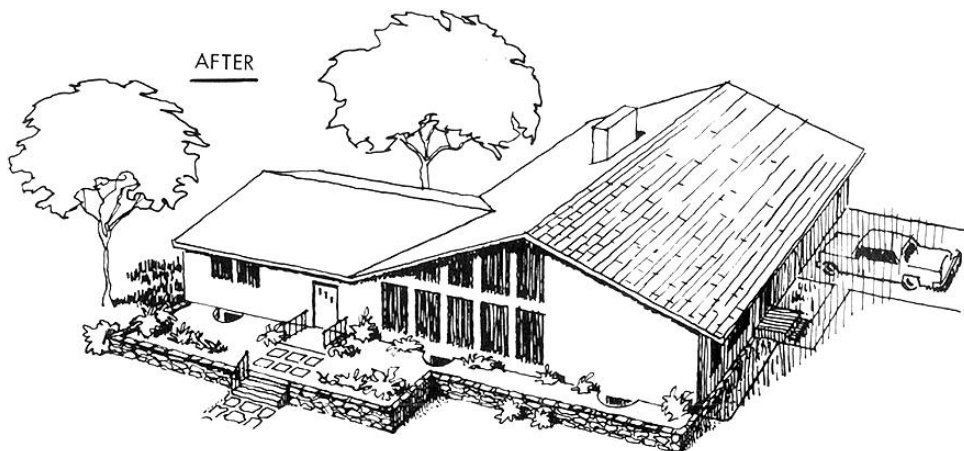

Where basements are not completely belowgrade, here are some additional ideas which can be used to increase the shielding of exposed basement walls. A brick, masonry, or stone planter box along one or more sides of the house will improve protection substantially, and will provide an attractive setting for shrubs and flowers as well. If the partially exposed wall is at the rear or side of the house, an elevated garden could be built with masonry retaining walls.

If the partially exposed walls have windows, these can still be used by providing window wells within the planter box or elevated garden area.

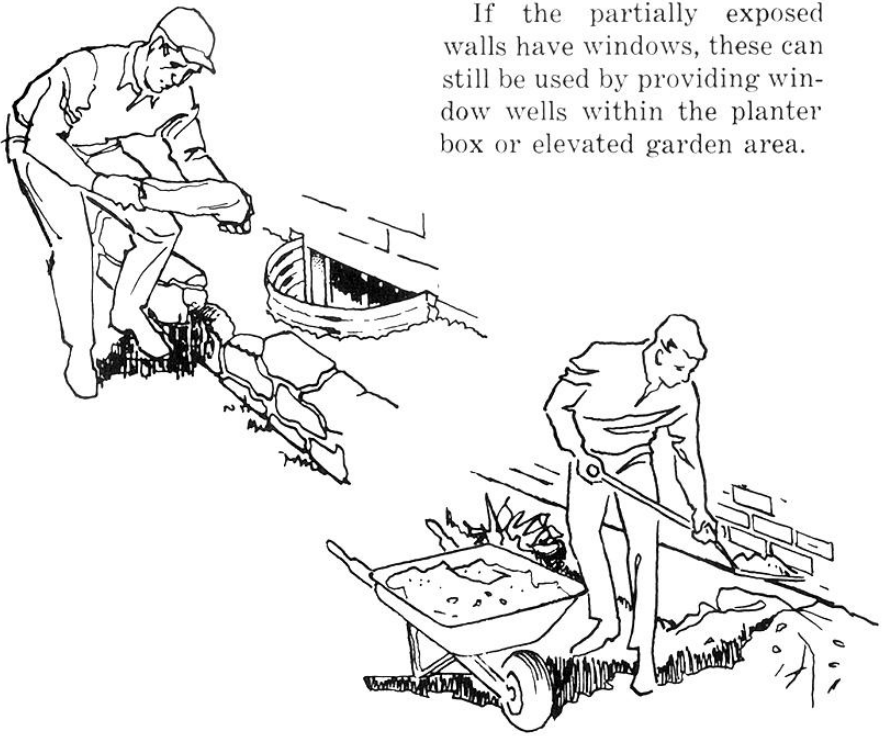

Your basement's PF will also be increased by providing additional shielding to the exposed section. This can be done by piling patio block, sand, earth, cordwood or similar materials against the exposed wall.



IMPROVISED SHELTERS

If a community shelter is not available and you have not provided your own fallout shelter, what would you do if you suddenly heard that the United States had been attacked with nuclear weapons?

You can still protect yourself and your family if you know what to do and if you act quickly. Pick out the corner of your basement with the highest ground level outside. That is the safest place in the basement. **NOW MAKE IT SAFER.**

In belowground basements, it is most important to have shielding overhead. Entered in the box labeled "Added Weight" on the back cover of this booklet is a number which tells you approximately how much weight of material should be placed over each square foot of the area over an improvised shelter, as illustrated on the following pages, to obtain a PF of 40, the minimum recommended.

If the letter "Y" appears in the box labeled "Added Weight" this means that adding overhead materials alone will not provide adequate protection against radiation unless heavy walls surrounding the shelter area are also added. If you already have a PF of 40 or more in the best corner of your basement, a zero, "0," will be shown in the box on the back cover labeled "Added Weight" indicating that additional weight is not required.

BASEMENT PF (PROTECTION FACTOR)		ADDED WEIGHT
CENTER	BEST CORNER	

YOUR OWN NUMBER WILL APPEAR IN THIS BOX  ON THE BACK COVER OF THIS BOOKLET.

Here are the weights of typical shielding materials:

- 4 inches of sand weighs approx. 35 pounds per sq. ft.
- 4 inches of wood weighs approx. 10 pounds per sq. ft.
- 4 inches of water weighs approx. 21 pounds per sq. ft.
- 4-inch cinder blocks weigh approx. 22 pounds per sq. ft.
- 4-inch bricks weigh approx. 32 pounds per sq. ft.
- 4-inch solid concrete blocks weigh approx. 48 pounds per sq. ft.
- 4 inches of library books weigh approx. 15 pounds per sq. ft.

If you have a sturdy table or workbench, place it in the corner. Quickly fill drawers or boxes with the heaviest material which is readily available—sand or dirt, bricks—or if you have nothing heavier, newspapers or books. Stack these materials on the top of the workbench. If a “Y” appears in the “Added Weight” box on the back cover of this booklet, then in order to obtain a PF of 40 in the shelter you must place an equivalent of 70 pounds per square foot on top of the shelter *as well* as adding heavy material on the sides of the shelter.

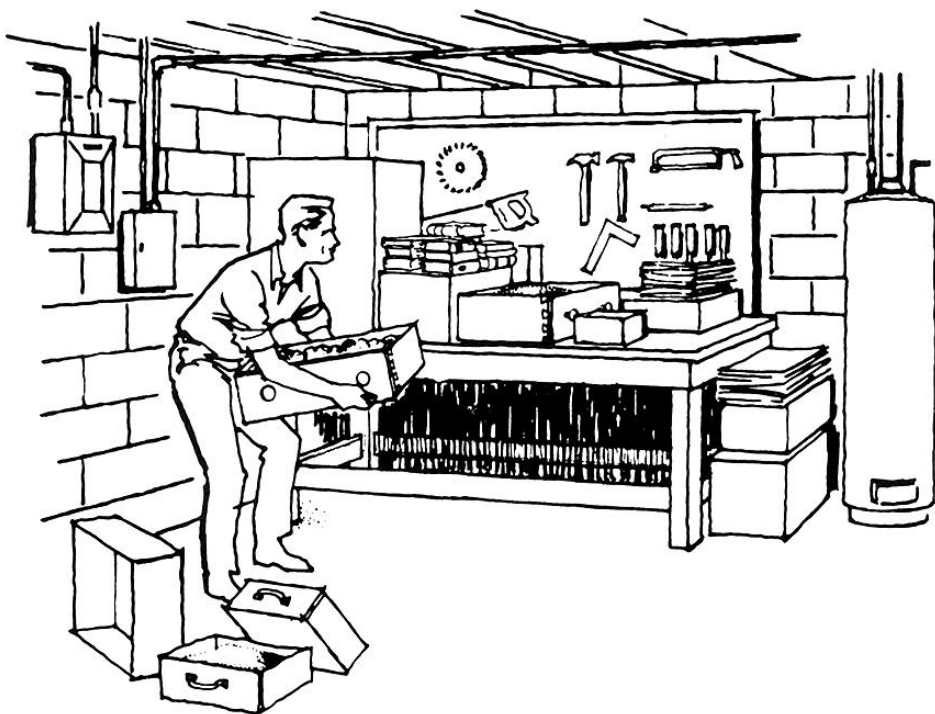

Be careful not to overload the table to the point where it will collapse.

IMPROVISED SHELTERS

If a workbench is not available, you can improvise a somewhat larger shelter area by using furniture, doors, dressers, or other materials. Remove doors from their hinges and place them over supports in the corner of your basement having the best protection. The supports for the table can be chests of drawers or anything that can take a heavy load. Use two or three doors over each support for this shelter to provide sufficient strength to carry the heavy loads placed on them. Place bricks, concrete blocks, earth- or sand-filled drawers, books, a collapsible children's swimming pool filled with water, etc., over the doors to provide an overhead shield. Use anything with weight that can be moved. The heavier the material, the more the protection. The minimum weight of material to be added for each square foot over the doors is shown in the "Added Weight" box on the back cover. If a "Y" appears in the "Added Weight" box, then in order to obtain a PF of 40 in the shelter, you must place 70 pounds per square foot on top of the shelter *as well* as adding heavy material to the sides of the shelter to serve as a vertical shield.



Be careful not to overload the doors to the point where the shelter will collapse.

If the figure entered in the box marked "Added Weight" on the back cover happens to be a number such as 30, this means that *every square foot* over the shelter area should be covered with material having a sufficient height so as to weigh 30 pounds. Using the weights of typical shielding materials as given on page 20, the required shielding material can be obtained by the following:

Approximately 3½ inches of earth or sand or

Approximately 12 inches of wood or

Approximately 6 inches of water or

4-inch (nominal thickness) layer of bricks or

Approximately 8 inches of library books

The shielding materials can be used individually such as providing a 3½-inch layer of sand completely over the improvised shelter or in conjunction with other materials as shown in the illustration on the opposite page.

If vertical shielding is required (a "Y" has appeared in the "Added Weight" box) this can be obtained by placing heavy material along the sides of the improvised shelter. Examples are: single course of bricks or concrete blocks, washing machine filled with water, chest of drawers filled with earth, deep-freeze, two rows of books, etc.

GENERAL

Until the extent of the radiation threat in your town is determined by trained monitors using special instruments, you should stay in your shelter as much as possible. For essential needs, you can leave your shelter for a few minutes. Before leaving the shelter for longer periods of time, listen to your radio station for information and instructions. A battery operated radio should be available for this purpose.

For quick reference, after you have finished reading this booklet, hang it up in the corner of your basement having the best protection so that it will be available in an emergency.

DETAILED PLANS ARE AVAILABLE FREE OF CHARGE

Detailed plans of many of the shelters you have read about in this booklet are available free of charge.

These plans contain construction details, suggested construction sequences and lists of materials needed. The plans supplement the material presented in this booklet.

Before constructing any of the permanent shielding devices described here, you should check to see that the construction conforms to your local building code.

The plans may be obtained by sending the attached post card to the Jeffersonville Census Operations Office, 1201 East 10th Street, Jeffersonville, Indiana 47130

Be sure that you identify the plan or plans you want as they are designated in the booklet:

- | | |
|---|---------------|
| PLAN A — CEILING MODIFICATION TO BASEMENT | — See page 8 |
| PLAN B — ALTERNATE CEILING MODIFICATION TO BASEMENT | — See page 10 |
| PLAN C — CONCRETE BLOCK SHELTER | — See page 12 |
| PLAN D — SNACK BAR SHELTER | — See page 14 |
| PLAN E — TILT-UP STORAGE UNIT | — See page 15 |
| PLAN F — LEAN-TO SHELTER | — See page 16 |

For further information on fallout protection and personal and family survival, consult your local Civil Defense Director and send for the personal and family survival booklet using the attached post card.

POSTAGE AND FEES PAID
OFFICE OF CIVIL DEFENSE

DEPARTMENT OF THE ARMY
OFFICE OF THE SECRETARY OF THE ARMY
OFFICE OF CIVIL DEFENSE
WASHINGTON, D.C. 20310

OFFICIAL BUSINESS

Jeffersonville Census Operations Office
1201 East 10th Street
Jeffersonville, Indiana 47130

For further information on fallout protection and personal and family survival, send for detailed shelter plans and the personal and family survival booklet using this post card.



POSTCARD ON INSIDE FLAP 

For quick reference, hang this booklet in the corner of your basement having the best fallout protection.